

subject to technical alterations

type: M200
range: 0 - 50 mm
range of indication: 0 - 50,5 mm
digital step:
scale interval: 0,050 mm
measuring force: 0,8 - 1,7 N
weight: 400 g

acceptable deviations
VDI/VDE/DGQ 2618 Bl. 12.1/13.1)
max. permissible errors "G": 0,050 mm
repeatability "r": 0,025 mm
reference temperature: 20° C
operation temperature: 10° C - 30° C
storage temperature: -10° C - 50° C

scale: 1 : 2
drawing-nr.: DAB-D4R50_KR_en
date of issue: 12.04.2013
name: Lange
revision status:
revision date:

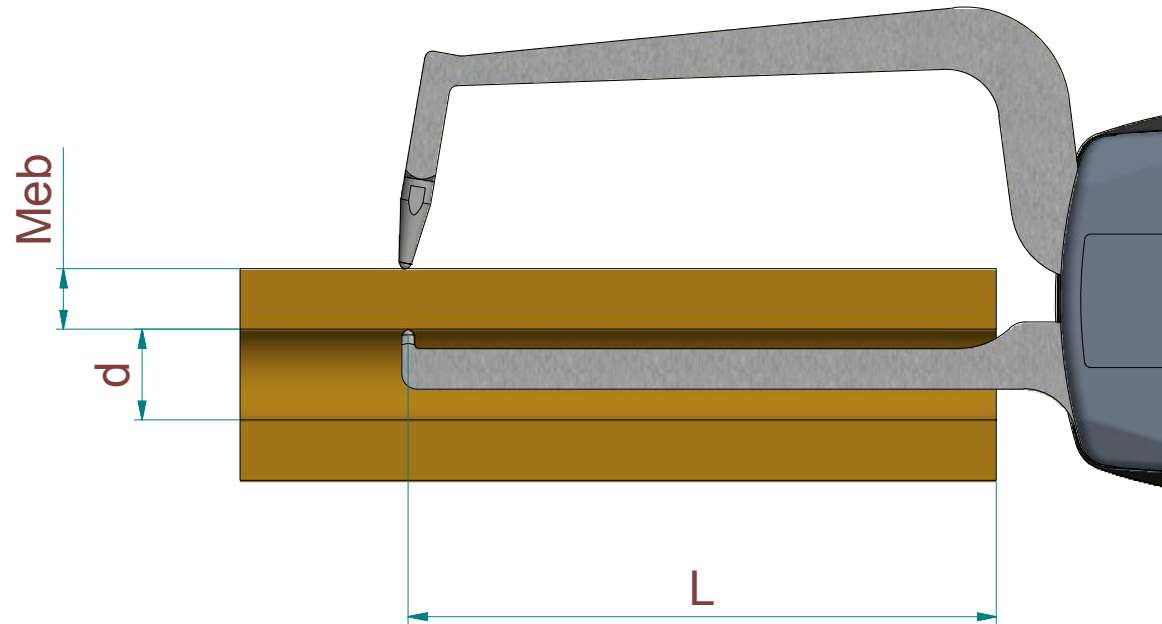

measuring capacity

internal diameter
d [mm]

		measuring range Meb [mm]									
		0,5	2	4	6	8	10	12	15	18	20
13		23,4	8,5	6,2	5,6	5,5	5,6	5,8	6,3	7,1	7,8
14		76,4	39,1	28,9	26,2	25,6	26,0	26,9	29,3	32,8	35,9
15		94,1	67,9	50,4	45,9	44,8	45,4	47,1	51,1	57,2	62,7
16		112,65	81,3	70,3	66,5	65,0	65,9	67,8	70,8	74,9	78,3
17		130,4	94,1	81,4	77,5	76,5	77,0	78,5	82,0	86,7	90,6
>18		148,9	107,5	93,1	88,5	87,4	88,1	89,8	93,7	99,1	103,5
	L										

L = maximum usable arm length [mm]

Example:
d = 14 Meb = 4 L = 28,9

subject to technical alterations

drawing-nr.: DAB-D4R50_KR_en
date of issue: 05.07.2013
name: Lange
revision status:
revision date: